

No	a*b	X
1	792x398	3
2	542x400	3
3	191x597	3
4	776x297	1
5	776x297	1
6	510x139	6
7	400x139	6
8	284x400	2
9	764x410	1
10	1168x50	1
11	830x410	1
12	830x410	1
13	764x410	1
14	1168x410	1
15	380x50	2
16	284x100	4
17	1200x450	1
18	568x410	1

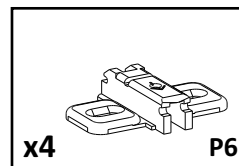

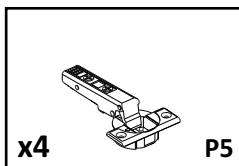
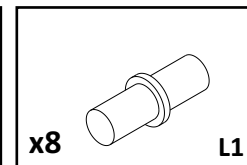
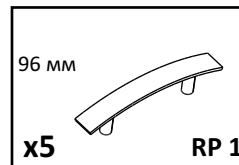
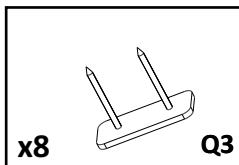
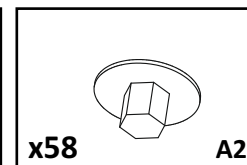
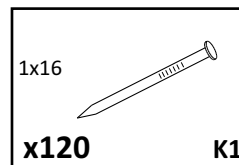
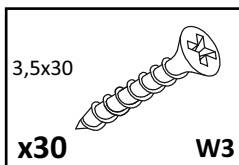
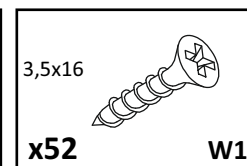
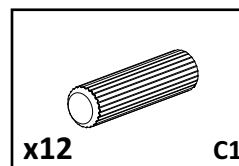
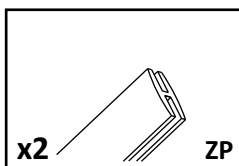
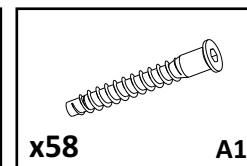
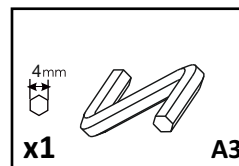
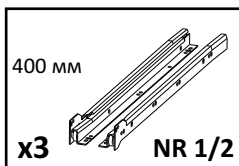
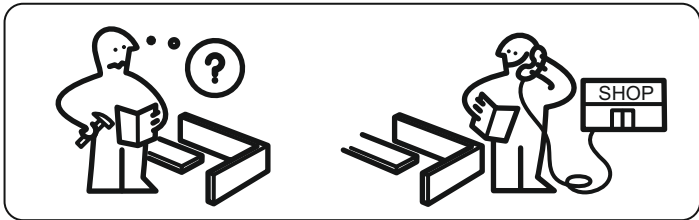
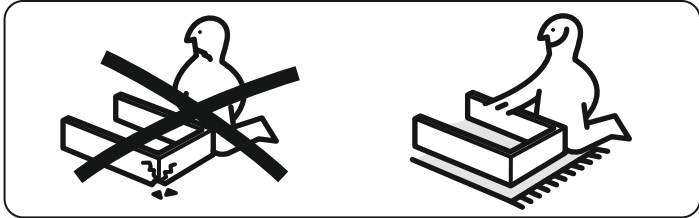
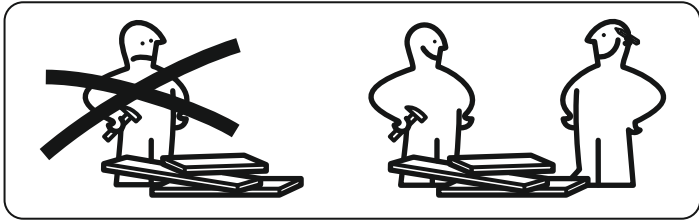
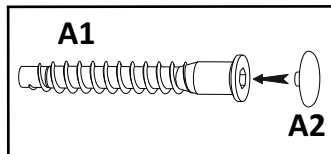
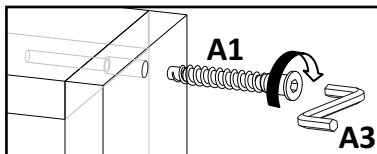
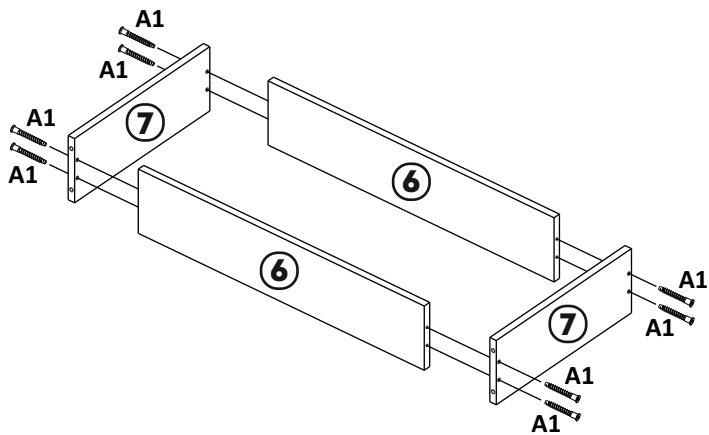
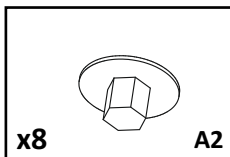
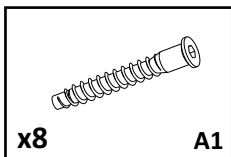
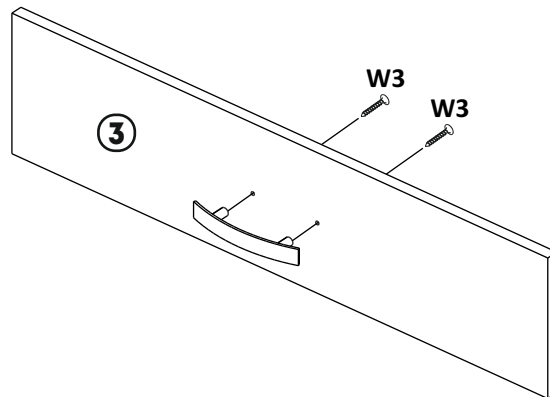
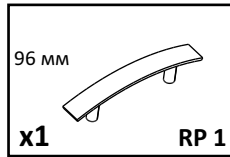
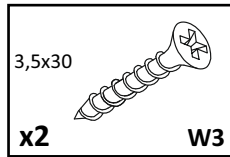
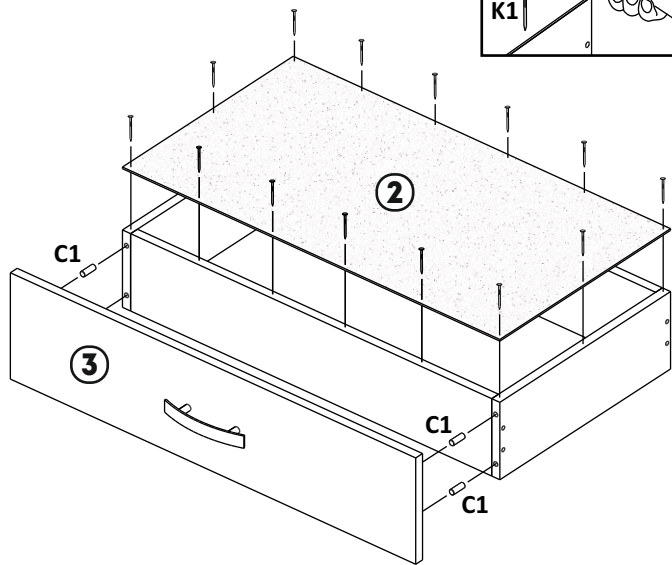
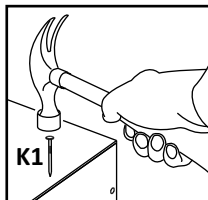
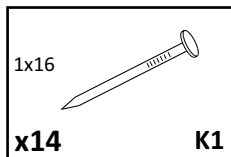
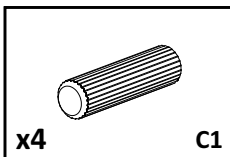
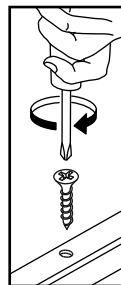
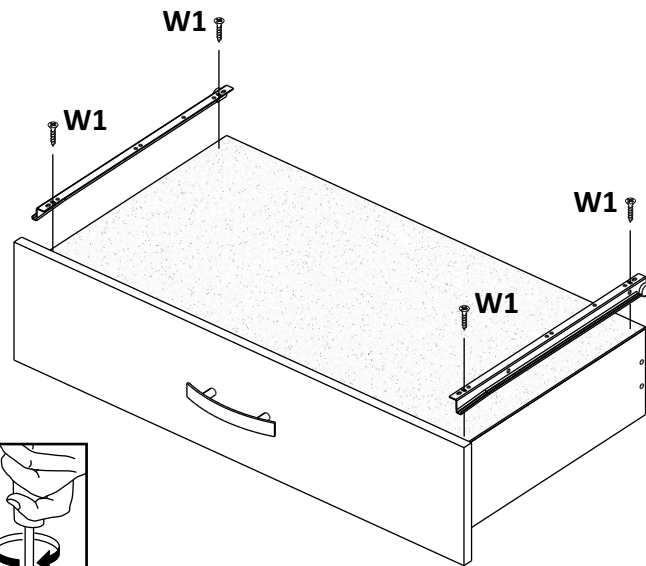
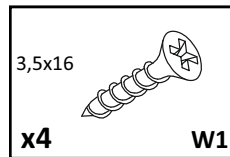
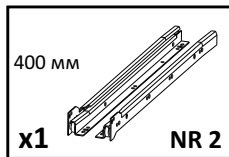

**1****2**

**3****4****6**

**5**

3,5x30

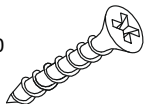

**x4**

**W3**

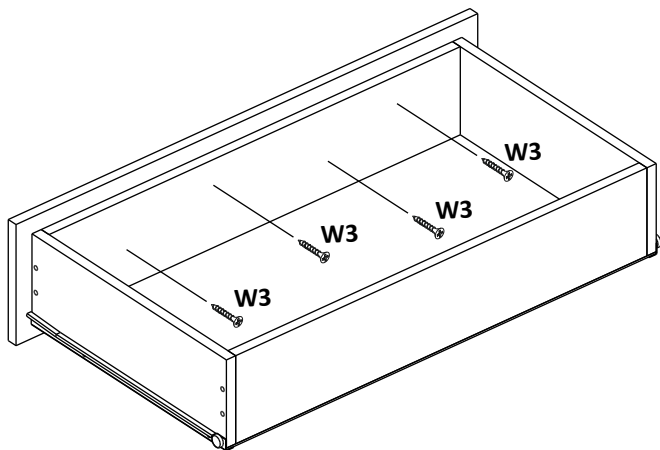

**6**

**x4**

**A1**

**x4**

**A2**

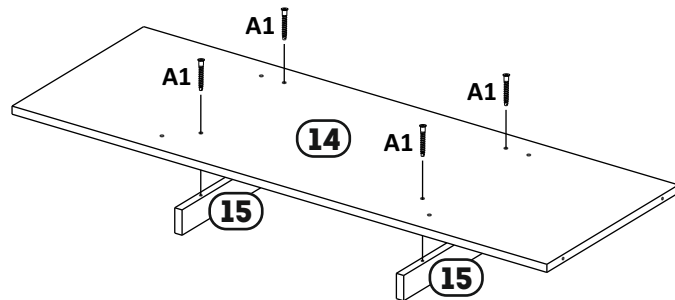
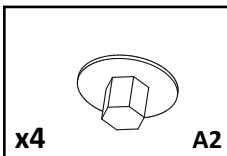
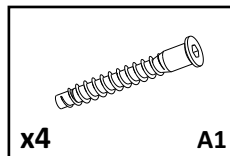

7

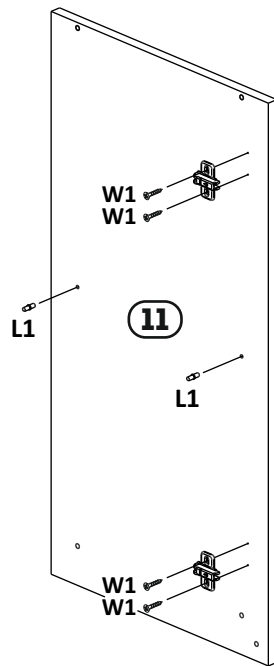
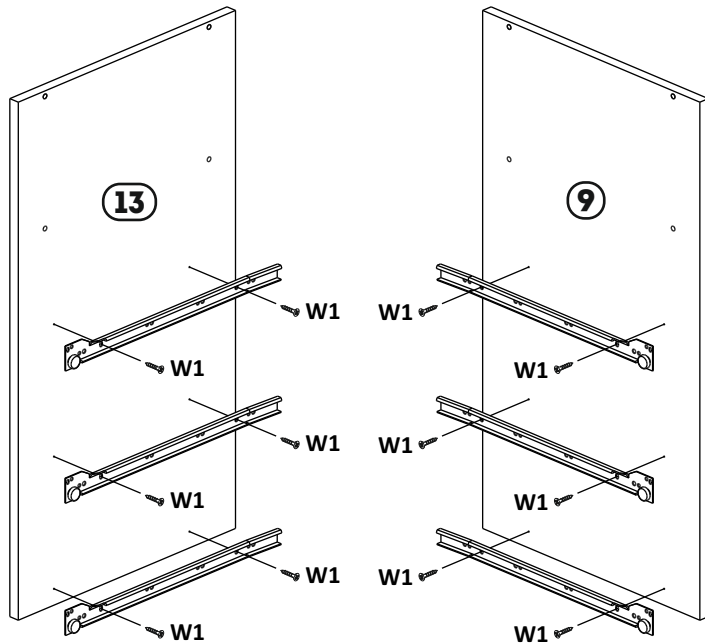
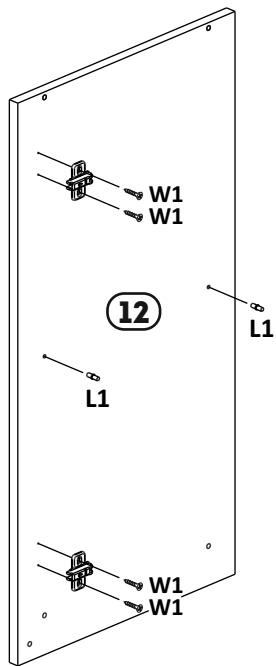
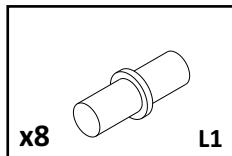
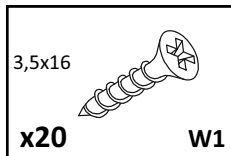
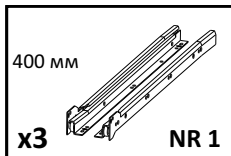
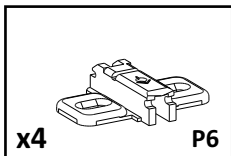



8

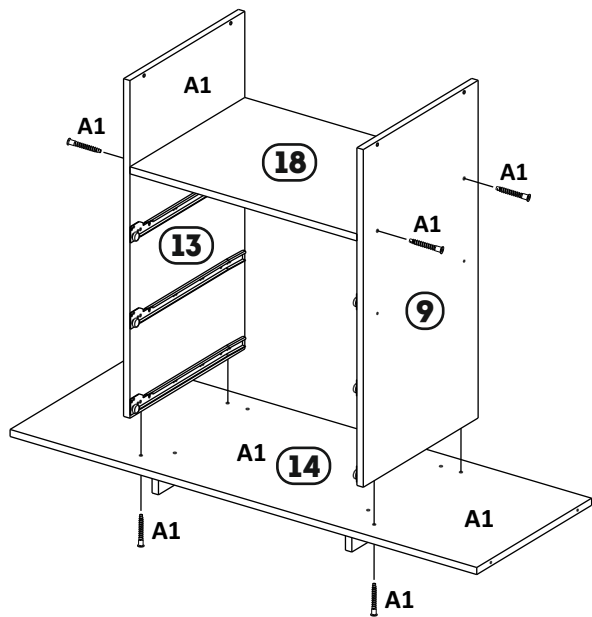
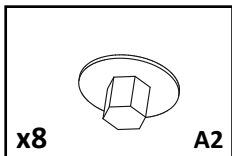
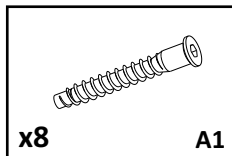

9

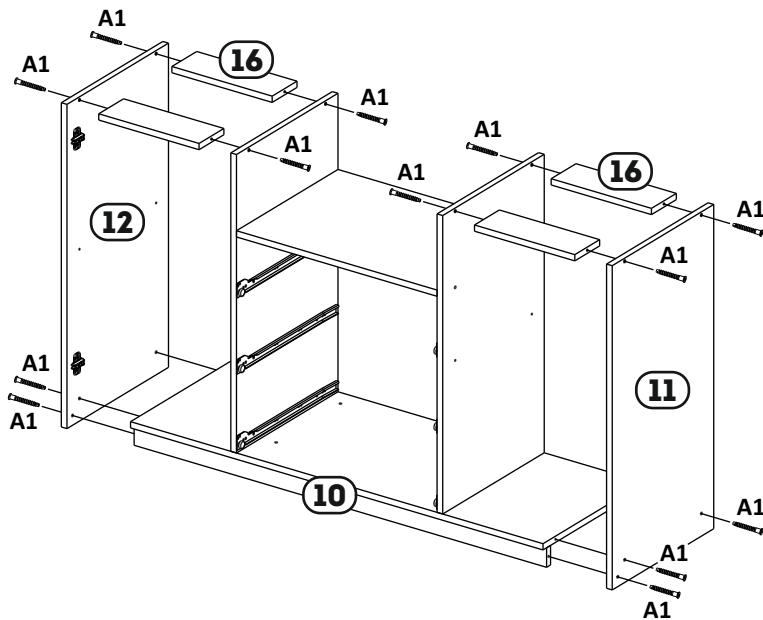
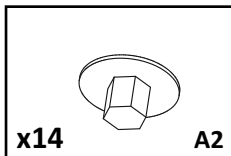
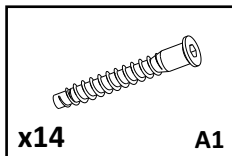

# 10

3,5x30

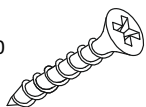

x8

W3

x8

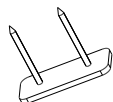

Q3

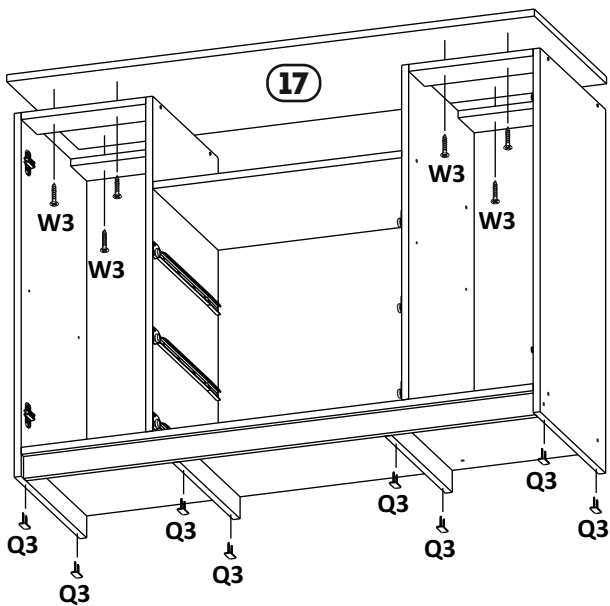

# 11

1x16

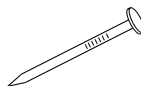

x78

K1

x2



ZP

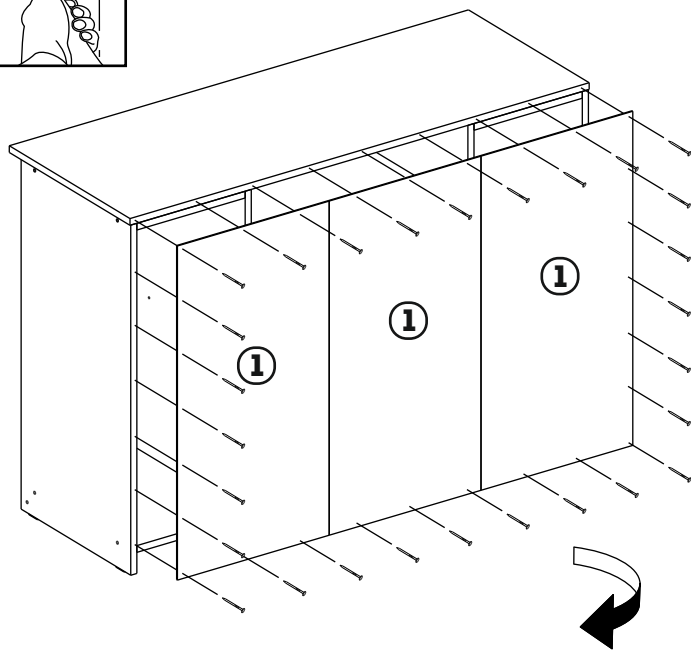
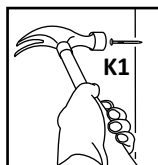
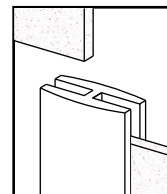

# 12

3,5x16

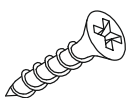

x8

W1

3,5x30

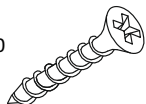

x4

W3

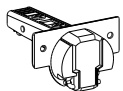

x4

P5

96 mm



x2

RP 1

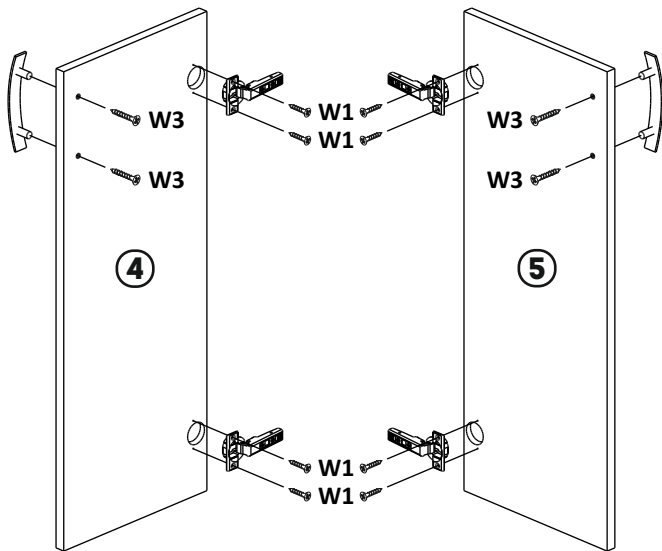

# 13

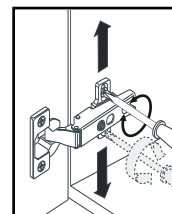
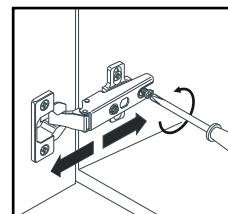
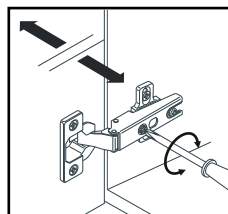
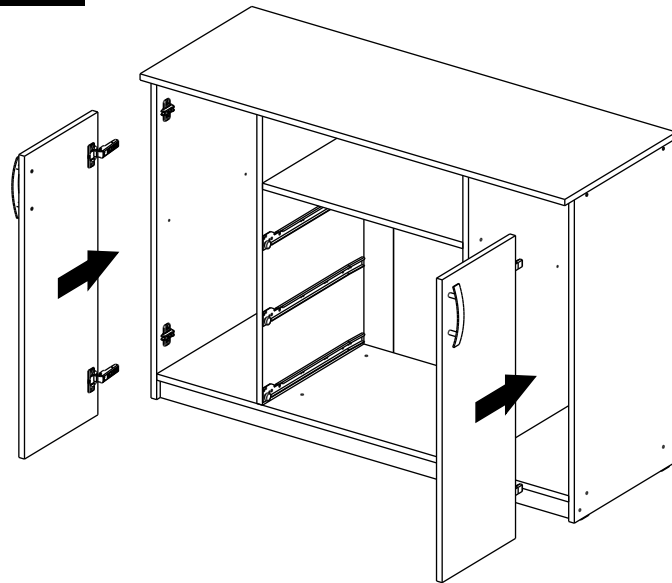

**14**

